

# HMPAL-LKFS

## Lumen and Kelvin Field Selectable Multi-Purpose Area Light

### FEATURES

- Field selectable 3000k (warm white), 4000k (neutral white), and 5000k (cool white) color temperatures.\*
  - Long-life LEDs provide 162,000 hours of operation with at least 70% of initial lumen output (L<sub>70</sub>), and 49,000 hours with at least 90% of initial lumen output (L<sub>90</sub>).\*\*
  - LED chromaticity based on < 6-step ANSI quadrangles.
  - LED color maintenance < 0.002 chromaticity shift ( $\Delta u'v'$ ) over the initial 6,000 hours of operation.
  - Provides a range of 14,000 to 40,000 nominal lumens.\*
  - IES roadway distributions include types III & V.
  - Universal 120-277V (50/60Hz) or 277-480V (50/60Hz) AC voltage with 6-foot incoming power cords.
  - 0-10vdc dimming drivers are standard.
  - Watertight, compression-type electrical connectors.
  - Power factor > 0.90.
  - Total harmonic distortion < 20%.
  - Color rendering index (R<sub>a</sub>) > 80.
  - Optional NEMA photocell receptacle & photocell.
  - Wall mount brackets and tenon adapters available (see page 6).
  - Die cast aluminum housing with dark bronze powder coat finish.
  - Polycarbonate lens.
- Easy installation in new construction or retrofit.

\*Contact factory for other color temperatures and lumen packages.  
\*\*L<sub>70</sub> hours are IES TM-21-11 calculated hours.

### WARRANTY & LISTINGS

- cULus listed for wet locations in ambient temperatures from -40°C to 50°C (-40°F to 122°F).
- DLC premium approved.
- Rated for 3G vibration.
- Lenses are rated IK08.
- Input transient surge protection (6kV).
- Complies with FCC Part 15, class A.
- IP65 rated for ingress protection.
- 5-year warranty of all electronics and housing.



### MOUNTING OPTIONS

Yoke

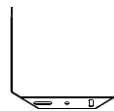

Trunnion

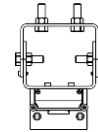

Slip-Fitter

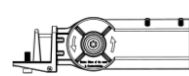

Adjustable arm

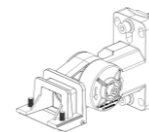

Arm

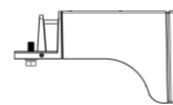

### NEMA PHOTOCELL

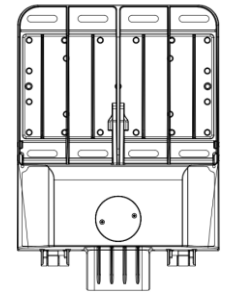
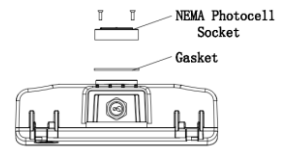

### ORDERING INFORMATION

Series	Nominal Lumen Output Selectable		Distribution		Input Voltage		NEMA Photocell Receptacle*		Mounting Means (One Required - Order Separately)*				
	24L	40L	T3	T5	Blank	UNC	Blank	P	MPAL-ARM	MPAL-ARM-A	MPAL-SF	MPAL-TM	MPAL-YM
HMPAL-LKFS	24,000/20,000/14,000	40,000/34,000/28,000	Type III	Type V	120-277	277-480	No receptacle	3-pin NEMA photocell receptacle	Arm mount	Arm mount	adjustable Slip-fitter mount	Trunnion mount	Yoke mount

\*NEMA photocell sold separately:  
JL-205C23-IP65

\*Pole tenons and tenon adapters available (see page 6)

2023.08



Job Name: \_\_\_\_\_

Type: \_\_\_\_\_

Part #: \_\_\_\_\_

Notes: \_\_\_\_\_

**ELECTRICAL DATA**

Series	Measurements	Low Lumens			Mid Lumens			High Lumens		
		3000K	4000K	5000K	3000K	4000K	5000K	3000K	4000K	5000K
HMPAL-24L-LKFS-T3	Lumens	14,649	16,173	15,115	20,273	22,824	20,939	24,056	26,598	24,591
	Watts	101	100	102	150	146	152	186	178	187
	Efficacy	145	162	148	135	156	138	130	150	131
	Input Current (A)	120V = 0.84A	120V = 0.83A	120V = 0.85A	120V = 1.25A	120V = 1.22A	120V = 1.27A	120V = 1.55A	120V = 1.48A	120V = 1.56A
240V = 0.42A		240V = 0.42A	240V = 0.43A	240V = 0.63A	240V = 0.61A	240V = 0.63A	240V = 0.78A	240V = 0.74A	240V = 0.78A	
277V = 0.36A		277V = 0.36A	277V = 0.37A	277V = 0.54A	277V = 0.53A	277V = 0.55A	277V = 0.67A	277V = 0.64A	277V = 0.68A	
Series	Measurements	Low Lumens			Mid Lumens			High Lumens		
		3000K	4000K	5000K	3000K	4000K	5000K	3000K	4000K	5000K
HMPAL-24L-LKFS-T5	Lumens	15,049	16,748	15,656	20,616	23,398	21,498	24,156	26,788	25,153
	Watts	101	100	102	150	145	151	186	178	187
	Efficacy	149	167	154	137	161	142	130	150	134
	Input Current (A)	120V = 0.84A	120V = 0.83A	120V = 0.85A	120V = 1.25A	120V = 1.21A	120V = 1.26A	120V = 1.55A	120V = 1.48A	120V = 1.56A
240V = 0.42A		240V = 0.42A	240V = 0.43A	240V = 0.63A	240V = 0.60A	240V = 0.63A	240V = 0.78A	240V = 0.74A	240V = 0.78A	
277V = 0.36A		277V = 0.36A	277V = 0.37A	277V = 0.54A	277V = 0.52A	277V = 0.55A	277V = 0.67A	277V = 0.64A	277V = 0.68A	
Series	Measurements	Low Lumens			Mid Lumens			High Lumens		
		3000K	4000K	5000K	3000K	4000K	5000K	3000K	4000K	5000K
HMPAL-40L-LKFS-T3	Lumens	28,924	32,211	30,104	33,874	37,248	35,140	40,091	44,173	41,188
	Watts	204	198	204	248	232	247	303	284	303
	Efficacy	142	163	148	137	160	142	132	156	136
	Input Current (A)	120V = 1.70A	120V = 1.65A	120V = 1.70A	120V = 2.07A	120V = 1.93A	120V = 2.06A	120V = 2.53A	120V = 2.37A	120V = 2.53A
240V = 0.85A		240V = 0.82A	240V = 0.85A	240V = 1.03A	240V = 0.97A	240V = 1.03A	240V = 1.26A	240V = 1.18A	240V = 1.26A	
277V = 0.74A		277V = 0.71A	277V = 0.74A	277V = 0.90A	277V = 0.84A	277V = 0.89A	277V = 1.09A	277V = 1.03A	277V = 1.09A	
Series	Measurements	Low Lumens			Mid Lumens			High Lumens		
		3000K	4000K	5000K	3000K	4000K	5000K	3000K	4000K	5000K
HMPAL-40L-LKFS-T5	Lumens	29,447	33,006	30,873	34,329	37,862	35,862	39,723	44,079	41,462
	Watts	204	197	203	247	231	246	298	283	297
	Efficacy	144	168	152	139	164	146	133	156	140
	Input Current (A)	120V = 1.70A	120V = 1.64A	120V = 1.69A	120V = 2.06A	120V = 1.93A	120V = 2.05A	120V = 2.48A	120V = 2.36A	120V = 2.48A
240V = 0.85A		240V = 0.82A	240V = 0.85A	240V = 1.03A	240V = 0.96A	240V = 1.03A	240V = 1.24A	240V = 1.18A	240V = 1.24A	
277V = 0.74A		277V = 0.71A	277V = 0.73A	277V = 0.89A	277V = 0.83A	277V = 0.89A	277V = 1.08A	277V = 1.02A	277V = 1.07A	

2023.08



Job Name: \_\_\_\_\_

Type: \_\_\_\_\_

Part #: \_\_\_\_\_

Notes: \_\_\_\_\_

**ELECTRICAL DATA**

Series	Measurements	Low Lumens			Mid Lumens			High Lumens		
		3000K	4000K	5000K	3000K	4000K	5000K	3000K	4000K	5000K
HMPAL-24L-LKFS-T3-UNC	Lumens	13,690	14,765	14,335	20,219	22,312	21,049	24,196	26,737	24,925
	Watts	99	96	100	153	149	155	192	183	193
	Efficacy	139	154	143	132	150	135	126	146	129
	Input Current (A)	277V = 0.36A	277V = 0.35A	277V = 0.36A	277V = 0.55A	277V = 0.54A	277V = 0.56A	277V = 0.69A	277V = 0.66A	277V = 0.70A
347V = 0.29A		347V = 0.28A	347V = 0.29A	347V = 0.44A	347V = 0.43A	347V = 0.45A	347V = 0.55A	347V = 0.53A	347V = 0.56A	
480V = 0.21A		480V = 0.20A	480V = 0.21A	480V = 0.32A	480V = 0.31A	480V = 0.32A	480V = 0.40A	480V = 0.38A	480V = 0.40A	
Series	Measurements	Low Lumens			Mid Lumens			High Lumens		
		3000K	4000K	5000K	3000K	4000K	5000K	3000K	4000K	5000K
HMPAL-24L-LKFS-T5-UNC	Lumens	13,916	14,870	14,480	20,405	22,381	21,093	24,505	26,840	25,382
	Watts	98	95	99	152	147	153	192	183	193
	Efficacy	142	157	147	134	153	138	128	147	131
	Input Current (A)	277V = 0.35A	277V = 0.34A	277V = 0.36A	277V = 0.55A	277V = 0.53A	277V = 0.55A	277V = 0.69A	277V = 0.66A	277V = 0.70A
347V = 0.28A		347V = 0.27A	347V = 0.29A	347V = 0.44A	347V = 0.42A	347V = 0.44A	347V = 0.55A	347V = 0.53A	347V = 0.56A	
480V = 0.20A		480V = 0.20A	480V = 0.21A	480V = 0.32A	480V = 0.31A	480V = 0.32A	480V = 0.40A	480V = 0.38A	480V = 0.40A	
Series	Measurements	Low Lumens			Mid Lumens			High Lumens		
		3000K	4000K	5000K	3000K	4000K	5000K	3000K	4000K	5000K
HMPAL-40L-LKFS-T3-UNC	Lumens	28,485	31,402	29,907	33,629	36,449	35,047	39,660	43,432	40,963
	Watts	203	198	202	246	236	246	297	283	296
	Efficacy	140	159	148	137	154	142	133	154	138
	Input Current (A)	277V = 0.73A	277V = 0.71A	277V = 0.73A	277V = 0.89A	277V = 0.85A	277V = 0.89A	277V = 1.07A	277V = 1.02A	277V = 1.07A
347V = 0.59A		347V = 0.57A	347V = 0.58A	347V = 0.71A	347V = 0.68A	347V = 0.71A	347V = 0.86A	347V = 0.82A	347V = 0.85A	
480V = 0.42A		480V = 0.41A	480V = 0.42A	480V = 0.51A	480V = 0.49A	480V = 0.51A	480V = 0.62A	480V = 0.59A	480V = 0.62A	
Series	Measurements	Low Lumens			Mid Lumens			High Lumens		
		3000K	4000K	5000K	3000K	4000K	5000K	3000K	4000K	5000K
HMPAL-40L-LKFS-T5-UNC	Lumens	28,731	31,840	30,214	33,918	36,884	35,413	39,890	44,057	41,651
	Watts	202	197	202	246	235	246	302	283	299
	Efficacy	142	161	150	138	157	144	132	156	139
	Input Current (A)	277V = 0.73A	277V = 0.71A	277V = 0.73A	277V = 0.89A	277V = 0.85A	277V = 0.89A	277V = 1.09A	277V = 1.02A	277V = 1.08A
347V = 0.58A		347V = 0.57A	347V = 0.58A	347V = 0.71A	347V = 0.68A	347V = 0.71A	347V = 0.87A	347V = 0.82A	347V = 0.86A	
480V = 0.42A		480V = 0.41A	480V = 0.42A	480V = 0.51A	480V = 0.49A	480V = 0.51A	480V = 0.63A	480V = 0.59A	480V = 0.62A	

2023.08

**PHOTOMETRIC DATA**
**HMPAL-24L-LKFS-T3**
**Luminaire Data**

Description	Multi Purpose Area Light PRO - LKFS 24L 5K T3
Total Lumens	24,601
Input Wattage	187
Efficacy (lm/W)	131
Max. Cd.	7588.58 (90H, 67V)
IES Classification	Type III
Longitudinal Classification	Medium

**Luminaire Classification Systems (LCS)**

LCS Zone	Lumens	%Lum	
FL	0-30	2,904	11.8%
FM	30-60	6,494	26.4%
FH	60-80	3,240	13.2%
FVH	80-90	323	1.3%
BL	0-30	2,684	10.9%
BM	30-60	5,794	23.6%
BH	60-80	2,933	11.9%
BVH	80-90	229	0.9%
UL	90-100	0	0.0%
UH	100-180	0	0.0%
<b>Total</b>	<b>24,601</b>	<b>100.0%</b>	
BUG Rating	B4-U0-G4		

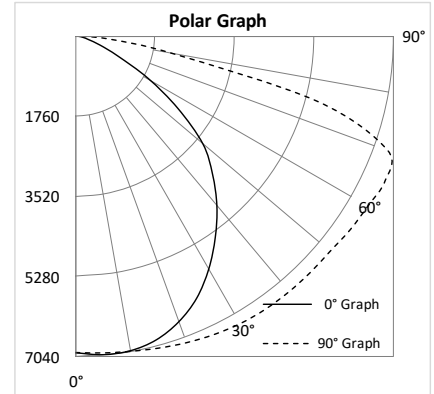
**HMPAL-24L-LKFS-T5**
**Luminaire Data**

Description	Multi Purpose Area Light PRO - LKFS 24L 5K T5
Total Lumens	25,157
Input Wattage	187
Efficacy (lm/W)	135
Max. Cd.	7742.22 (337.5H, 22V)
IES Classification	Type VS
Longitudinal Classification	Very Short

**Luminaire Classification Systems (LCS)**

LCS Zone	Lumens	%Lum	
FL	0-30	3,101	12.3%
FM	30-60	7,290	29.0%
FH	60-80	2,486	9.9%
FVH	80-90	42	0.2%
BL	0-30	2,784	11.1%
BM	30-60	6,505	25.9%
BH	60-80	2,884	11.5%
BVH	80-90	66	0.3%
UL	90-100	0	0.0%
UH	100-180	0	0.0%
<b>Total</b>	<b>25,157</b>	<b>100.0%</b>	
BUG Rating	B4-U0-G2		

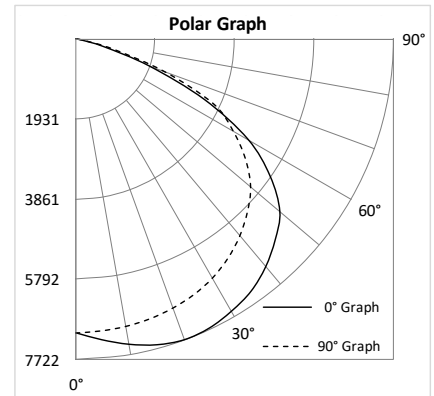
**HMPAL-40L-LKFS-T3**
**Luminaire Data**

Description	Multi Purpose Area Light PRO - LKFS 40L 5K T3
Total Lumens	41,239
Input Wattage	302
Efficacy (lm/W)	136
Max. Cd.	12840.24 (270H, 67V)
IES Classification	Type III
Longitudinal Classification	Medium

**Luminaire Classification Systems (LCS)**

LCS Zone	Lumens	%Lum	
FL	0-30	4,831	11.7%
FM	30-60	10,848	26.3%
FH	60-80	5,398	13.1%
FVH	80-90	483	1.2%
BL	0-30	4,488	10.9%
BM	30-60	9,786	23.7%
BH	60-80	5,010	12.1%
BVH	80-90	394	1.0%
UL	90-100	0	0.0%
UH	100-180	0	0.0%
<b>Total</b>	<b>41,239</b>	<b>100.0%</b>	
BUG Rating	B5-U0-G5		

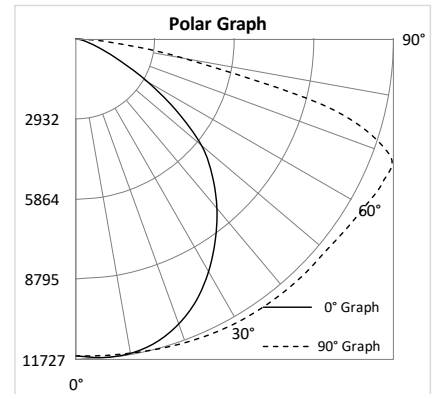
**HMPAL-40L-LKFS-T5**
**Luminaire Data**

Description	Multi Purpose Area Light PRO - LKFS 40L 5K T5
Total Lumens	41,980
Input Wattage	302
Efficacy (lm/W)	139
Max. Cd.	12368.81 (360H, 22V)
IES Classification	Type VS
Longitudinal Classification	Very Short

**Luminaire Classification Systems (LCS)**

LCS Zone	Lumens	%Lum	
FL	0-30	5,024	12.0%
FM	30-60	12,076	28.8%
FH	60-80	4,397	10.5%
FVH	80-90	79	0.2%
BL	0-30	4,671	11.1%
BM	30-60	11,064	26.4%
BH	60-80	4,581	10.9%
BVH	80-90	89	0.2%
UL	90-100	0	0.0%
UH	100-180	0	0.0%
<b>Total</b>	<b>41,980</b>	<b>100.0%</b>	
BUG Rating	B5-U0-G2		

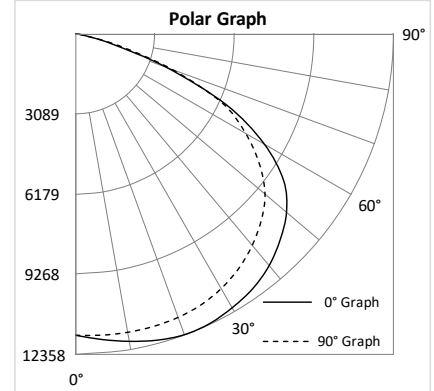

**DIMENSIONS**

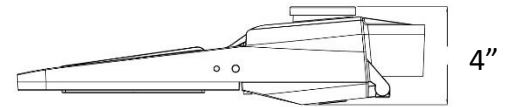
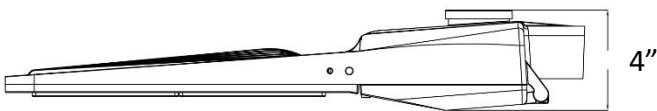
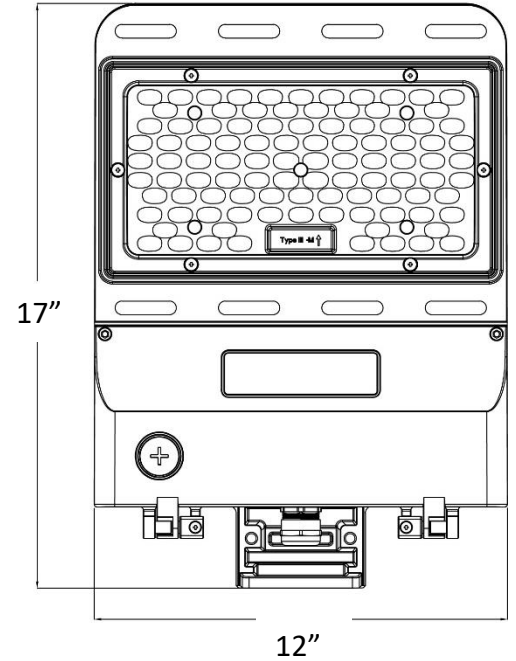
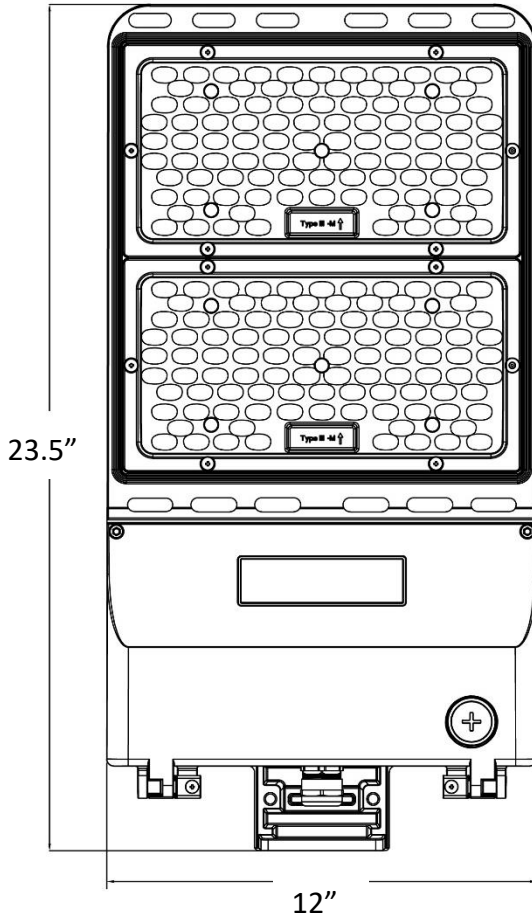

**EFFECTIVE PROJECTED AREAS (EPA's)**

24L

Front = 1.4 square feet  
 Side = 0.5 square feet  
 Face = 0.3 square feet

40L

Front = 2.0 square feet  
 Side = 0.7 square feet  
 Face = 0.3 square feet

**MOUNTING ACCESSORIES**

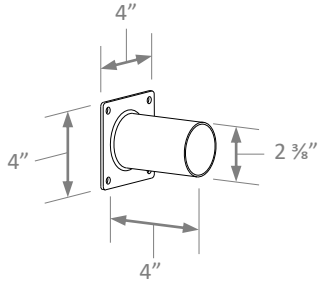

**Wall Mount Bracket**

LEDMPALPRO-WMB

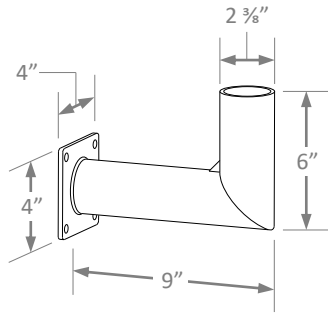

**Wall Mount Bracket, 90°**

LEDMPALPRO-WMB90

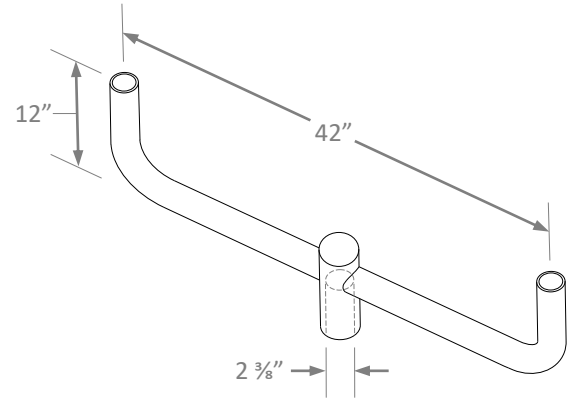

**Double 180° Bullhorn Mounting Bracket**

LEDMPALPRO-D180BH

Bullhorn requires slip-fitter mount

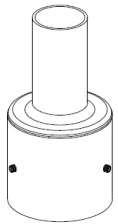

4SQR-SP-D

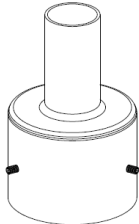

5SQR-SP-D

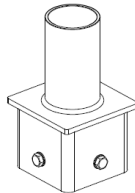

4SQ-SP-D

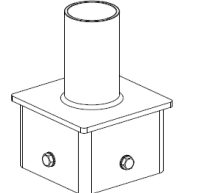

5SQ-SP-D

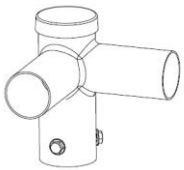

R60-SP2-90-D

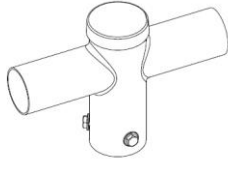

R60-SP2-180-D

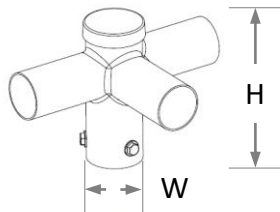

R60-SP3-90-D

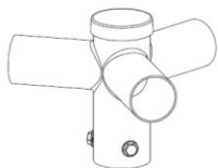

R60-SP3-120-D

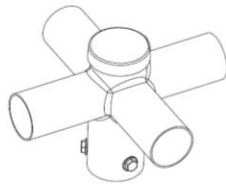

R60-SP4-90-D

Part Number	Description	L	W	H
4SQR-SP-D	4" round pole tenon	-	4.2"	8.6"
5SQR-SP-D	5" round pole tenon	-	5.2"	8.6"
4SQ-SP-D	4" square pole tenon	3.6"	3.6"	7.2"
5SQ-SP-D	5" square pole tenon	4.6"	4.6"	7.2"
R60-SP2-90-D	Tenon adapter 90° double	-	ID 2.5"	7.3"
R60-SP2-180-D	Tenon adapter 180° double	-	ID 2.5"	7.3"
R60-SP3-90-D	Tenon adapter 90° triple	-	ID 2.5"	7.3"
R60-SP3-120-D	Tenon adapter 120° triple	-	ID 2.5"	7.3"
R60-SP4-90-D	Tenon adapter 90° quadruple	-	ID 2.5"	7.3"